

# Product Data Sheet



Product Name	ZSR25-NKL
Product Category	Side Release Buckle
Material	ZINC/ POM polyacetal
COLOR	
Cord Size	-
Cord Type	-
Webbing Size	25mm
Production	Japan
Remarks	-

Image



Size

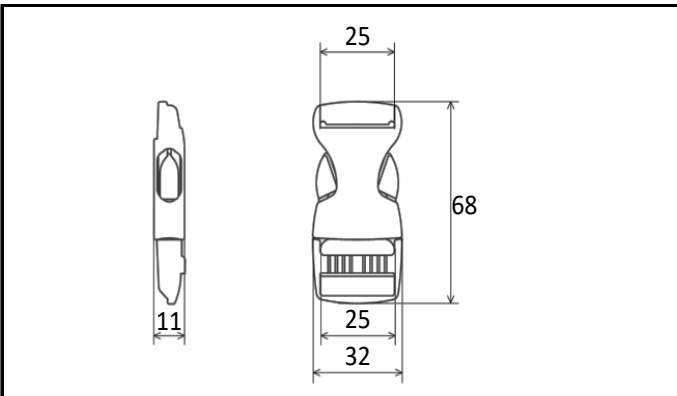

Specs

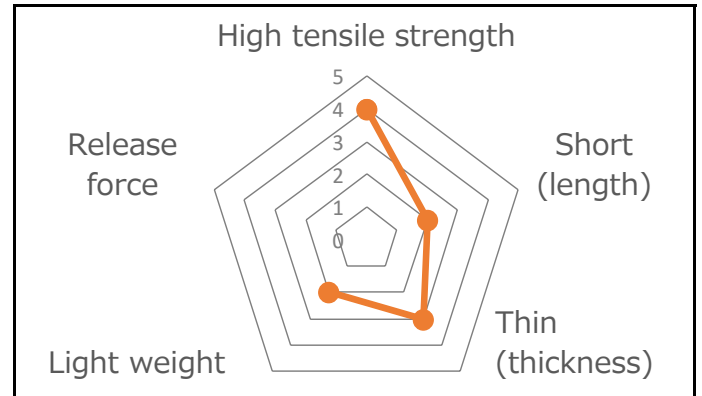

Example Usage

▶ Operation      ▶ Application example      ▶ Parts